

HIGH SPEED TURBO

Oilfree Class 0

DRIVEN TO CHANGE THE ESTABLISHED

BOGE HST.

Setting a new benchmark for oil-free compressed air.

BOGE introduces the next advancement in oil-free compressed air. This is more than a small step in a record of pioneering accomplishments that spans more than 100 years; the High-Speed Turbo technology is the successful completion of a quantum leap. By radically reducing the number of components (the compressors have shrunk to half the size and a third of the weight) while simultaneously using a unique design principle that guarantees low-wear operation, a significant improvement in efficiency has been achieved.

- Superior drive concept
- Very high energy density
- Absolutely no oil or lubricant required
- Extremely small footprint
- Minimum maintenance and running costs
- Long service life
- Substantial noise reduction





„Quite possibly the most efficient way to produce oil-free compressed air, and almost certainly the most intelligent“

Thorsten Meier, Managing Director BOGE KOMPRESSOREN

BOGE HST. The driving force for fundamental change.

THE DESIGN PRINCIPLE

The permanent magnet motor does not require any gears in order to reach the high motor speeds achieved. And since the motor shaft is supported by air alone, oil is not needed anywhere in the system. A high-quality titanium impeller sits at both ends of the motor shaft and works in combination with the diffuser and the spiral casing to generate compressed air. Considered design has resulted in a cooling concept that ensures the air is effectively cooled after each of the three compression stages, while the integrated frequency converters allow the volumetric flow to be adjusted seamlessly to the compressed air demand.

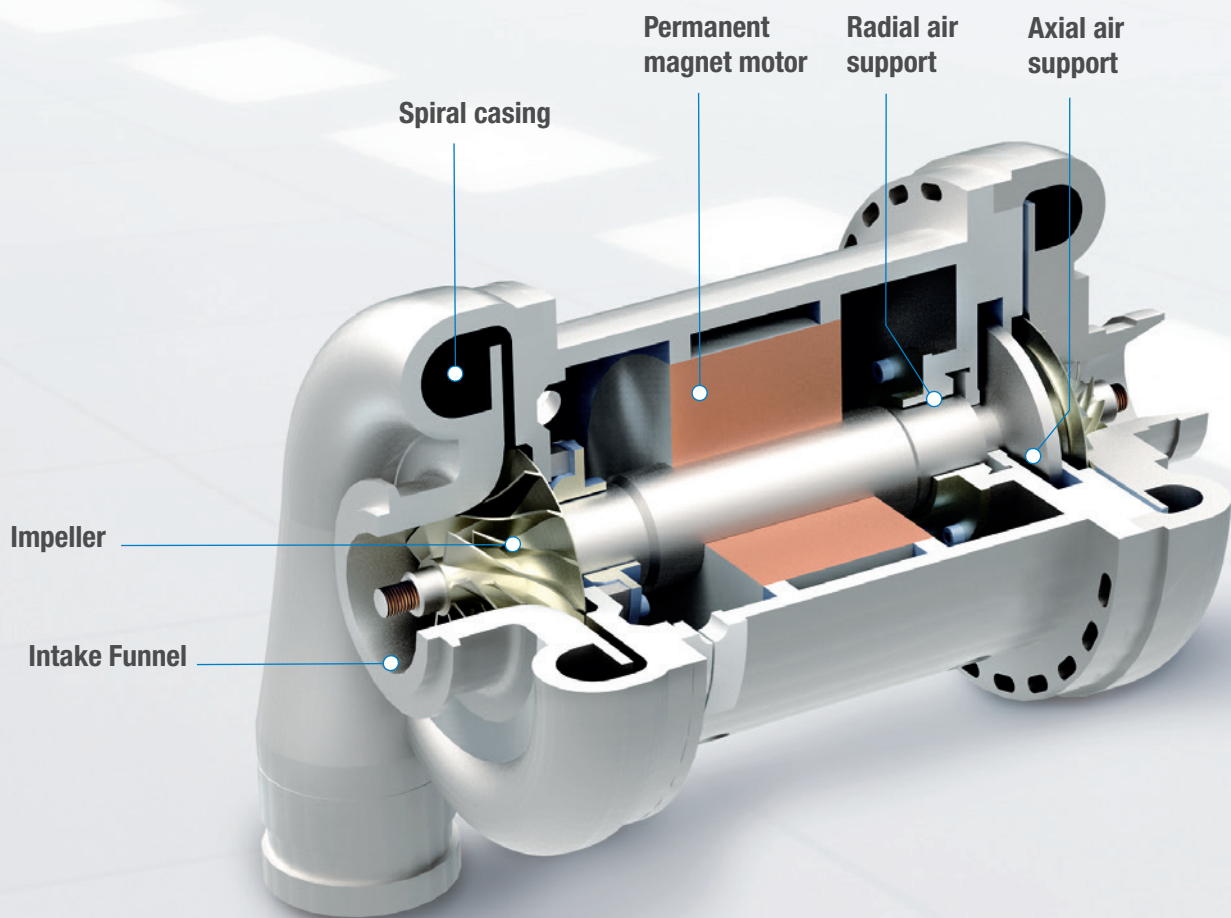

When there is no oil, then none can escape. Our new High Speed Turbo Compressors are designed so that the entire drive mechanism operates without any lubricants at all; giving you total confidence that your compressed air is 100% oil-free. A permanent magnet motor and the unique air-supported motor shaft ensure dependable low-maintenance operation with minimal energy use. This means that HST technology from BOGE is not just unique in terms of its drive technology, it also sets new standards in minimising footprint, weight and noise emissions.

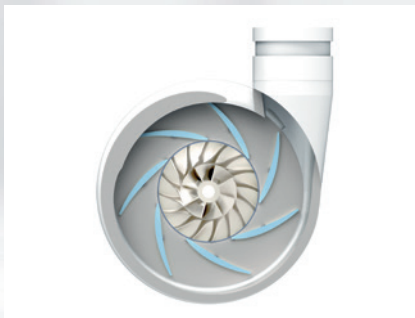

DYNAMIC COMPRESSION

The turbo technology has got past its baptism of fire, having introduced an impeller that rotates with a high speed which sets the axially drawn in air in rapid motion. To enable the high velocity energy to be converted effectively into compression energy, we have focused on matching the geometry of the impeller, diffuser and the spiral casing in HST compressors.



TITANIUM IMPELLER

Reliability is the top priority, which meant that titanium was the material of choice for the impeller. This not only is the best match in terms of weight but is also recognised for its durability. Closer tolerances are also possible thanks to the properties of this material.

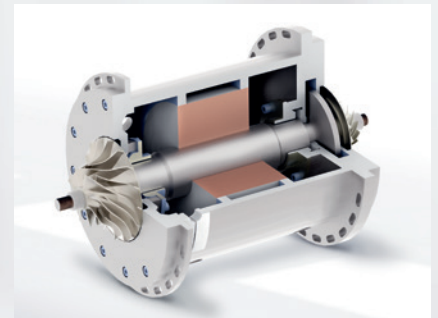

PERMANENT MAGNET MOTOR

Permanent magnet motors lend themselves perfectly to realising the goals of BOGE developers; obtaining a downsizing breakthrough whilst achieving a highly efficient and reliable operation. The small size of these motors enables extremely high speeds to be reached, while also being able to attain a very high energy density.

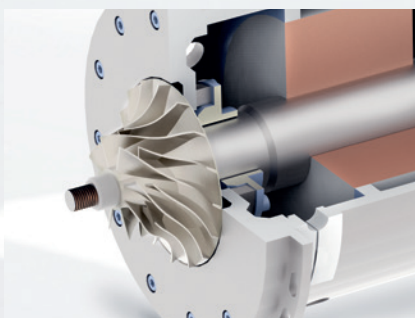

AIR-SUPPORTED MOTOR SHAFT

In contrast to magnetic bearings or roller bearings, an air-supported shaft requires no external energy input or any operating media except air to achieve maximum speeds. The air bearing stabilises itself and needs no auxiliary bearings. Furthermore, virtually wear-free and correspondingly low-maintenance operation is now possible with this type of bearing.

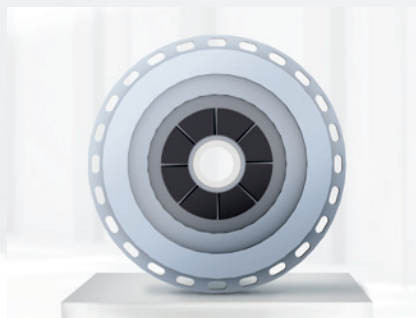

COMPACT DIMENSIONS THANKS TO AIR BEARINGS

When oil or grease are dispensed with, standard bearings must be replaced with air bearings. This may sound easy but actually poses a real challenge for engineers seeking to optimise the interaction of the various bearing components looking to achieve a smoother operation. By using a principle already used in the aviation industry, a far smaller footprint is created, leading to a set of impressive results.



TOUCH CONTROL

Based on the modular focus control 2.0 – one of the most cutting-edge compressor controls of our time – the touchscreen operation and an intuitive user interface is very satisfying. Up to four frequency controlled High Speed Turbo Compressors can be controlled with the greatest of ease – authorised users can log on easily and touch-free with an RFID chip.

BOGE HST. The new drive for industry.

HIGHER EFFICIENCY WITH FEWER RESOURCES – THIS IS THE PHILOSOPHY BEHIND THE BOGE HST CONCEPT

To achieve cost-cutting targets that were previously unthinkable, new methods using fewer components have been adopted. This saves resources, reduces maintenance costs and directly impacts on the cost price. Reliability in particular is boosted, since components that have not been fitted in the first place cannot wear out. The results at a glance:

Reduced number of components – reliability boost

| Number of components | BOGE HST | Oil-free screw compressor |
|----------------------|----------|---------------------------|
| Gears | 0 | 3 |
| Bearings | 6 | 19 |
| Seals | 3 | 17 |
| Fan motor | 0 | 1 |
| Lubrication system | 0 | 1 |
| Oil pump | 0 | 1 |

New dimensions

| | | |
|----------------------|---------------|----------|
| Footprint | < 50 % | 100 % |
| Weight | ca. 33 % | 100 % |
| Sound pressure level | from 63 dB(A) | 80 dB(A) |



This boost to innovation lies in the air: The turbine drive has proved its worth over several decades, and what once gave buoyancy to the aviation industry is now bringing the compressed air sector up to speed. Some design changes have been necessary. With the high energy density of their motors, compact High Speed Turbo compressors now weigh less than a third of the weight of an oil-free screw compressor. And as a world first, BOGE is raising the bar with its air-supported motor shaft – opening the door to speeds far in excess of 100,000 rpm.

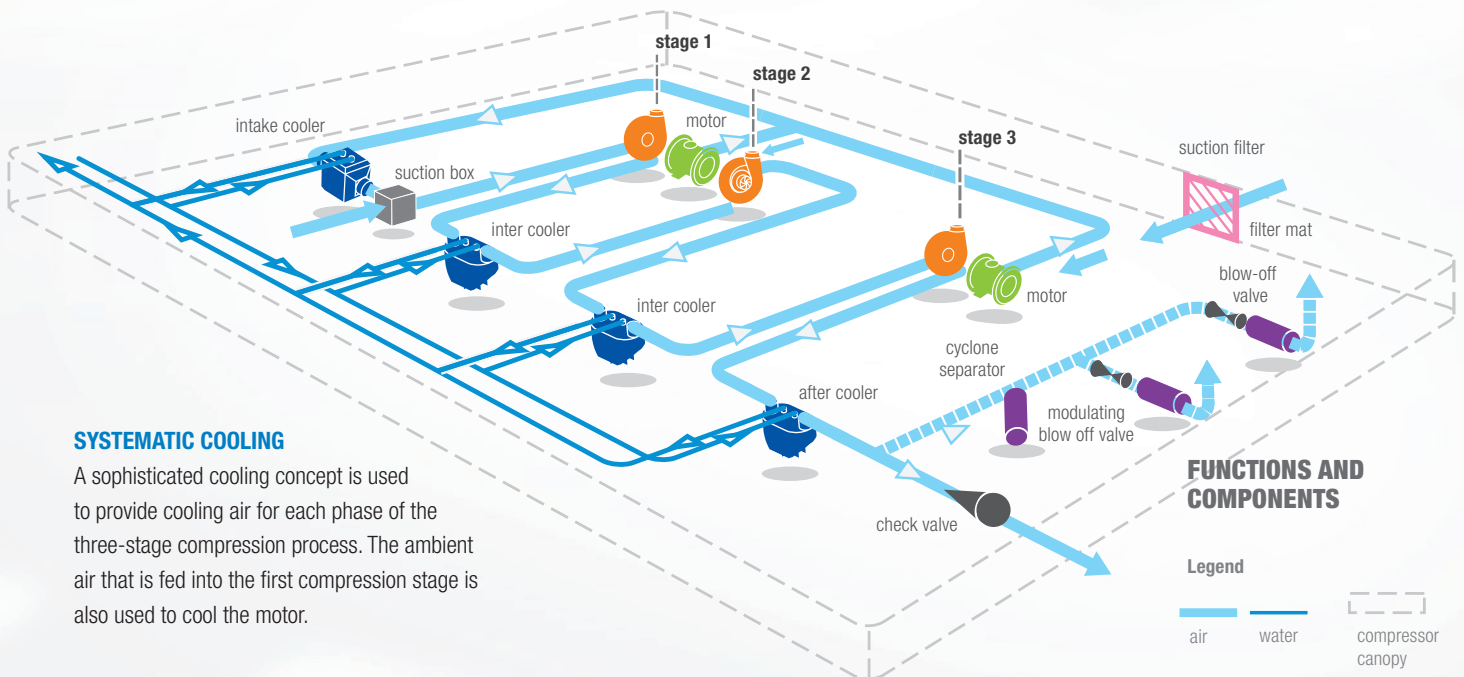

SYSTEMATIC COOLING

A sophisticated cooling concept is used to provide cooling air for each phase of the three-stage compression process. The ambient air that is fed into the first compression stage is also used to cool the motor.

FUNCTIONS AND COMPONENTS

Legend
 — air — water — compressor canopy

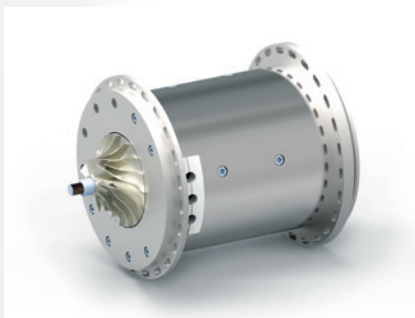

THE 2-MOTOR PRINCIPLE

The three-stage compression process uses two permanent magnet motors that operate with impellers of differing sizes. The first motor drives two impellers for the first two compression stages, while the second motor is responsible for the third stage only.

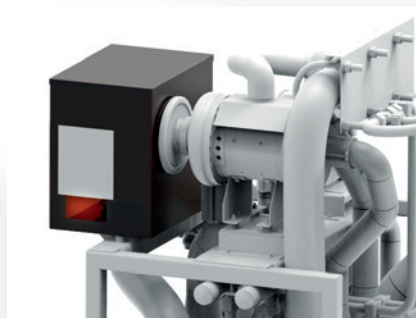

THE INTAKE BOX

The main purpose of the intake box is to optimise both the air stream and the temperature of the intake air to ensure that the best possible specific characteristics are achieved for the particular ambient conditions. The numerous practical extra functions it offers include the ability to adjust the motor to the ideal temperature.



THE FILTER SYSTEM

Since the differential pressure is critical for the efficiency of the compressor, large filter surfaces ensure both very high separation efficiency and low differential pressures are achieved.

BOGE HST. The breakthrough in cost control.



PLANNING CERTAINTY THAT YOU CAN DEPEND ON

The amount that you save on maintenance just by dispensing with gears, an oil system and many other components is already significant. But the savings do not stop there – they range from the purchase price to lower transportation expenses. All in all, this gives you maximum planning certainty – and all thanks to a proven technology that stands out thanks to its up-to-the-minute efficiency.

AN INNOVATION THAT'S KINDER TO THE ENVIRONMENT

It was to be expected that a technical innovation like the High Speed Turbo Compressor would be in the interests of conserving the environment. But the real surprise was the actual extent of its eco-friendliness: it achieves top marks for efficiency even without the heat recovery option and the small CO2 emission preserves the environment.

Everyone who depends on a steady supply of oil-free compressed air can achieve previously inconceivable savings by using BOGE's "High Speed Turbo" technology. Top marks for efficiency and a drastically reduced cost of ownership are not the only benefits. The environment also gains thanks to the sustainable design principle that requires far less space and resources and effectively keeps noise in check.



OIL-FREE CLASS 0

This classification is effortlessly attained by the new BOGE HST. With a unique air-supported motor shaft and the complete removal of any lubrication, these compressors are in fact totally oil-free compressed air systems.

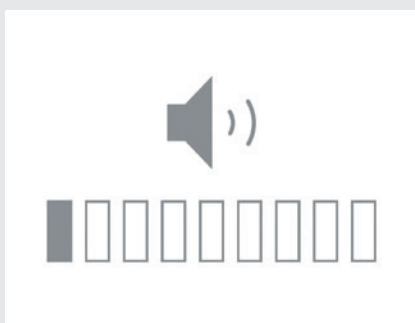

SOUND PRESSURE LEVEL

What is just as striking as the small footprint is the compressor's unobtrusive running sound and its far lower sound pressure level: Whilst an oil-free screw compressor notches up 80 dB(A), a BOGE HST is remarkably quiet at no more than 63 kb(A) and works within a pleasing octave range. This allows the added bonus of greater flexibility in situating the compressors, and also saving you the cost of installing additional expensive soundproofing measures.

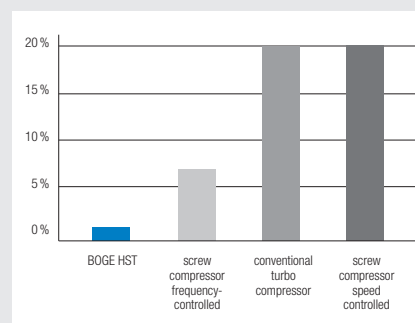

ENERGY USE IN IDLE STATE

With their high energy efficiency at every stage BOGE HST stand out, but they probably use even less energy during idle time than the ceiling lights in your compressor room. One reason for this extraordinarily low figure lies in the fact that there is no fan motor to consume any extra energy. This is a further advantage when costing these compressors.

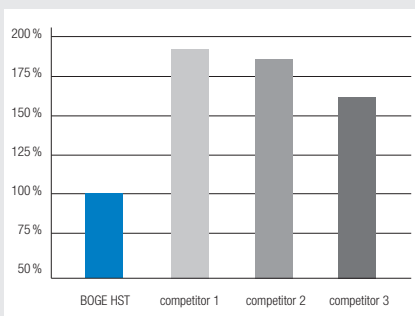

COST PRICE

It is not without good reason that we speak of the dawn of a new era when referring to High Speed Turbo technology: the low purchase price makes "oil-free" technology more affordable than ever before. Even though only high-quality materials are used, the systematic reduction of components still yields significant savings.

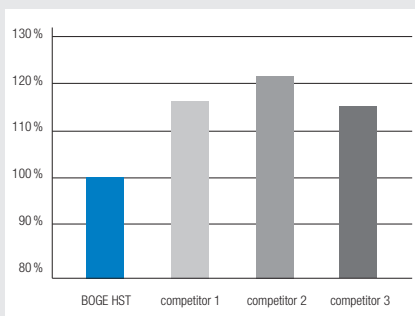

CO₂ EMISSIONS

The superiority of the High Speed Turbo compressor is also evident with regard to CO₂ emissions. The remarkable energy efficiency of the system ensures a sustained reduction in the burden on the environment.

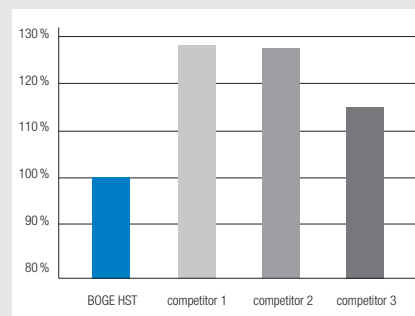

TOTAL COST OF OWNERSHIP

With minimised energy requirements, low-wear operation and accordingly long maintenance intervals – High Speed Turbo technology is practically tailor made for meeting even ambitious savings targets.

BOGE HST. The compact range for practically any use.

HST MODELS AT A GLANCE



HST 55



HST 110



HST 220

Please also take note of the Technical Data on the enclosed data sheet.

HST DELIVERS A SHOW-STOPPING PERFORMANCE IN EVEN THE MOST DEMANDING APPLICATIONS

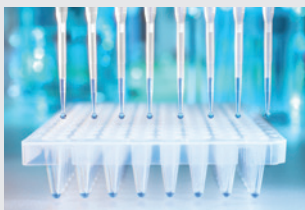

Pharmaceutical Industry

100% oil-free compressed air is an indispensable standard requirement in the pharmaceutical industry and other sensitive sectors. BOGE HST completely banish the residual risk of oil inadvertently escaping into the ambient air.



Industrial Paint Shops

BOGE HST are the ideal choice for uses such as in paint lines, where the slightest trace of oil can lead to downtime. HST also substantially reduces electricity costs.



Food Processing Industry

Dairies understandably rely on oil-free compressed air, but heat recovery with BOGE HST is also attracting interest, as a great deal of process heat is required in producing dried milk.

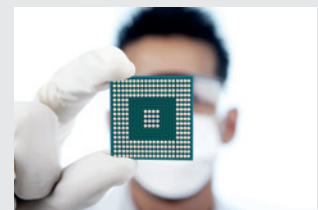

Semiconductor Production

Where stringent cleanroom conditions are paramount, it is extremely important that compressed air is not contaminated with oil. We can guarantee this with our BOGE HST, since no oil is used in the first place ...

There are numerous sensitive manufacturing sectors where high-quality oil-free compressed air is essential. But whether we are talking about the pharmaceutical or food processing industry, refineries or breweries, three-stage HST compressors with a standard pressure of 7.5 bar will bring a renewed impetus to every production process calling for a steady supply of compressed air. These can be used as base-load or peak-load compressors, in three power ratings from 55 - 220 kW.



BOGE SELECTCAIR: THE PERFECT SERVICE PROGRAMME FOR EVERY NEED

BOGE selectcair

BOGE High Speed Turbo marks a fundamental change, and this is not without consequences for the Aftermarket programme. With BOGE selectcair HST users can call on a comprehensive network of services that aims for continuous improvement. BOGE selectcair offers the three programme options BASIC, ORIGINAL and PREMIUM. This allows all HST users to select the services that are perfectly tailored to their individual needs. For further information about BOGE selectcair see www.boge.com/hst.



Absolutely Oil-free

The best guarantee for oil-free compressed air is to banish the use of lubricants right from the start. The BOGE HST series is a shining example of how this can be achieved.



Outstanding Efficiency

BOGE HST stands for top marks for energy efficiency. This is particularly noticeable in idle mode where energy consumption is practically nil.

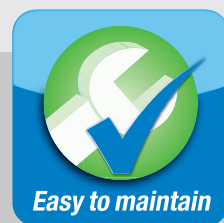

Lowest Maintenance Costs

Wear-free impeller operation contributes to reducing maintenance costs to a substantially lower level than usual.



Premium Engineering

Only the combination of premium quality and intelligent innovative solutions achieves the particular quality that sets the BOGE HST series apart: innovative quality.

BOGE KOMPRESSOREN Otto Boge GmbH & Co. KG

P.O. Box 10 07 13 · 33507 Bielefeld

Otto-Boge-Straße 1–7 · 33739 Bielefeld

Tel. +49 5206 601-0 · Fax +49 5206 601-200

info@boge.com · www.boge.com

Best **O**f **G**erman **E**ngineering

In more than 120 countries worldwide customers from mechanical engineering, industry and trade trust the BOGE know-how in planning, development and production of high quality compressed air systems. Already in its fourth generation, the family-owned company puts all its experience in the development of innovative solutions and outstanding efficient products for the compressed air industry.

Rightly, therefore, the last name of the founder Otto Boge stands for „Best Of German Engineering“ today. Who puts emphasis on German engineering skills, highest safety, reliable services and energy efficiency, accesses quality products from BOGE because they have been supplying „the air to work“ for more than 100 years.

OUR RANGES OF SERVICES INCLUDE THE FOLLOWING:

- Energy efficient systems development
- Plant design and engineering
- Industry 4.0 solutions, system control and visualisation
- High Speed Turbo compressors
- Oil-free piston, screw and scroll compressors
- Oil injected screw compressors and oil lubricated piston compressors
- Compressed air treatment
- Compressed air distribution and storage
- Compressed air accessories
- Compressed air service
- Nitrogen and oxygen generators

